

BP2 LOCKOUT RECEIVERS

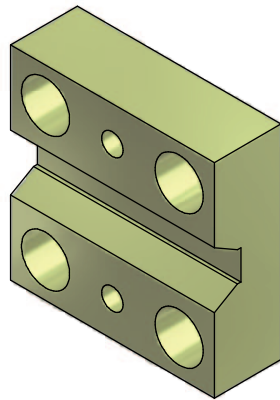

BP2NE90

2-WAY RECEIVER - FOR USE WITH CONICAL NOSE PIN AS LOCATOR

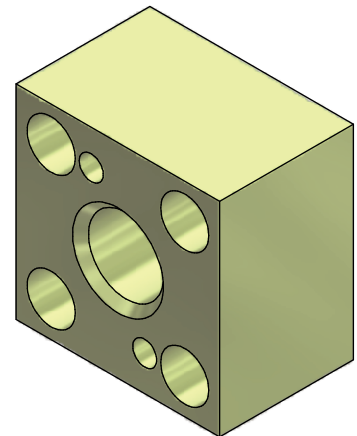

BP2NE92

CLEARANCE HOLE - FOR USE WITH FLAT/CONICAL NOSE PIN AS SAFETY LOCK-OUT
50mm STROKE

BP2NE95

CLEARANCE HOLE - FOR USE WITH FLAT/CONICAL NOSE PIN AS SAFETY LOCK-OUT
25mm STROKE

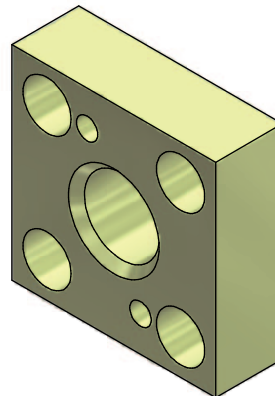

RELEASED 6/28/17

BP2 RECEIVERS

LOCATIONAL PIN RECEIVER (2-WAY)

ORDER AS #BP2NE90 FOR
CONICAL PIN NOSE OPTION "1"
CARB & HARDENED Rc 45-50

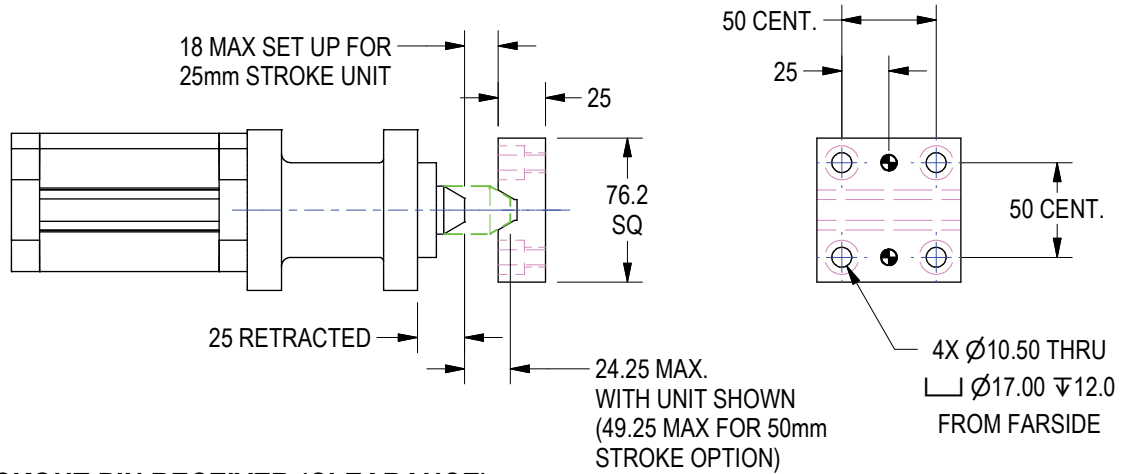

LOCKOUT PIN RECEIVER (CLEARANCE)

ORDER AS #BP2NE92 FOR
PIN NOSE OPTION "2", 50mm STROKE

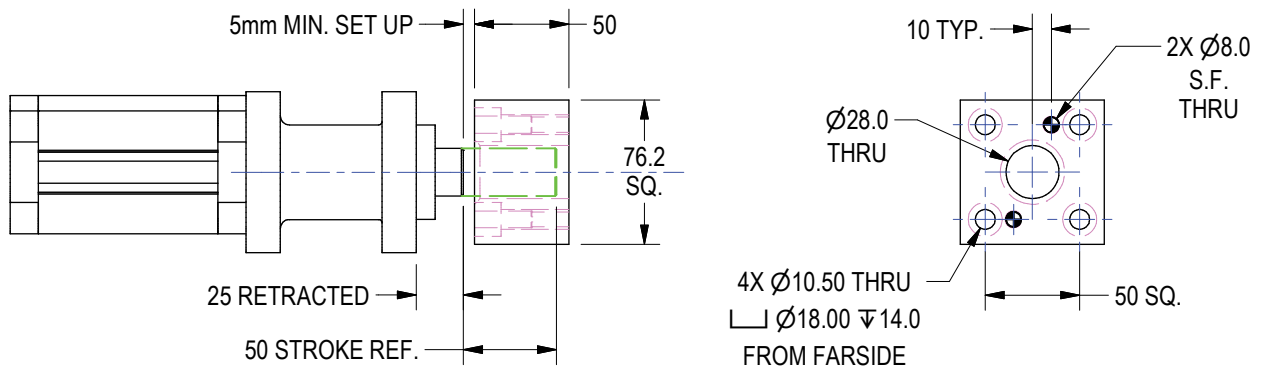

LOCKOUT PIN RECEIVER (CLEARANCE)

ORDER AS #BP2NE95 FOR
PIN NOSE OPTION "2", 25mm STROKE

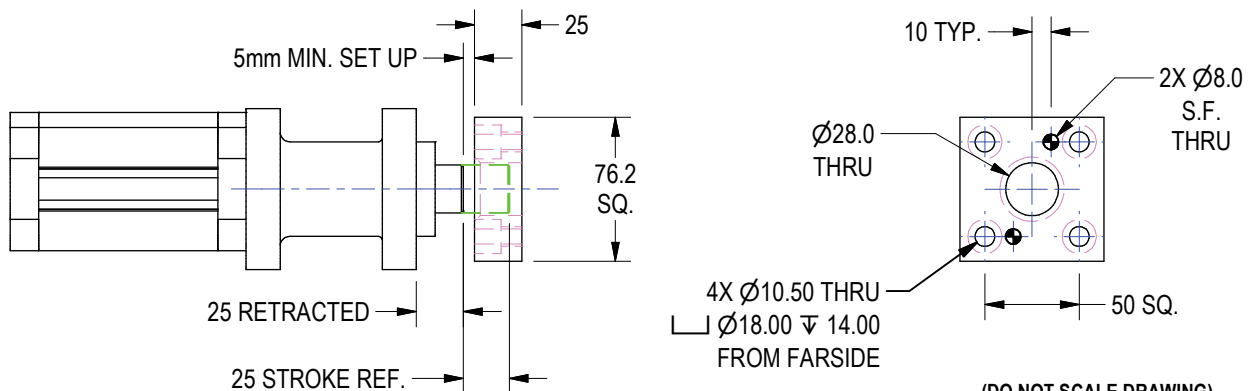

(DO NOT SCALE DRAWING)

WELKER
ENGINEERED PRODUCTS
800-229-0890 www.welkerproducts.com